

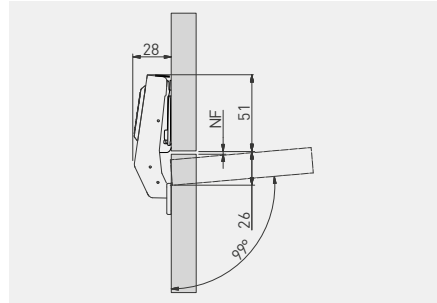

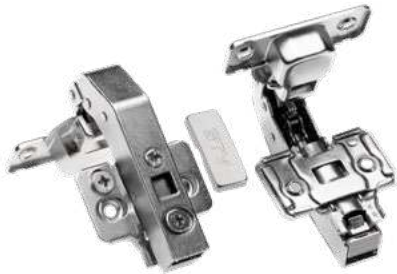



Zawias równoległy HCKT z regulacją mimośrodową  
 Parallel hinge HCKT with eccentric adjustment  
 Петля под фальшпанель HCKT с эксцентриком



					
ZM-HCKT90-3DBE0	H=0	—	—	nikiel nickel никель	stal / ZnAl steel / ZnAl сталь / ZnAl

